

HomeWorks Digital 0.1% 3-wire Constant Voltage 24 V $\overline{\text{DC}}$ LED Controller with Soft-on, Fade-to-Black

The HomeWorks digital 0.1% constant voltage controller is a high-performance LED controller capable of controlling up to 96 W of 24 V $\overline{\text{DC}}$ constant voltage loads. This controller provides smooth and continuous dimming down to 0.1% low-end. It is ideal for use with strip lighting in applications such as coves, under or over cabinet lighting and pathway lighting. The controller is UL \circledR Listed with an integrated wiring compartment and can be mounted up to 150 ft (45 m) away from the load.

Features

- Continuous, flicker-free dimming from 100% to 0.1%¹.
 - Soft-on, Fade-to-Black operation for HomeWorks digital: fades smoothly between 0% and 0.1% when turned on and off for an incandescent like experience.²
 - UL \circledR Listed for United States and Canada (cULus \circledR).
 - Field Adjustment Knob offers customer low-end light output tuning for better fixture-to-fixture matching.
 - Guaranteed dimming performance when used with Lutron controls:
 - HomeWorks digital module
 - Lutron 3-wire controls and interfaces.
 - Protected from miswires of input power, up to 277 V \sim , to HomeWorks digital control inputs.
 - Rated lifetime of 50,000 hours at 40 °C (104 °F) ambient temperature and maximum loading.
 - FCC Part 15
 - Class A (277 V \sim)
 - Class B (120 V \sim)
 - Inrush limiting allows full loading of circuit breakers without nuisance tripping.
 - 100% end-of-line performance tested at a Lutron factory.
- RoHS compliant.
 - Restores all settings after power failure.
 - Barrier provided for Class 2 separation in the wiring compartment.
 - Redundant connections on line and control terminals for easy daisy chain wiring.
 - Redundant connections on output terminals allow for easy wiring of two LED load home runs.
 - Class 2 output designed to withstand hot swap.
 - For more information please visit: www.lutron.com

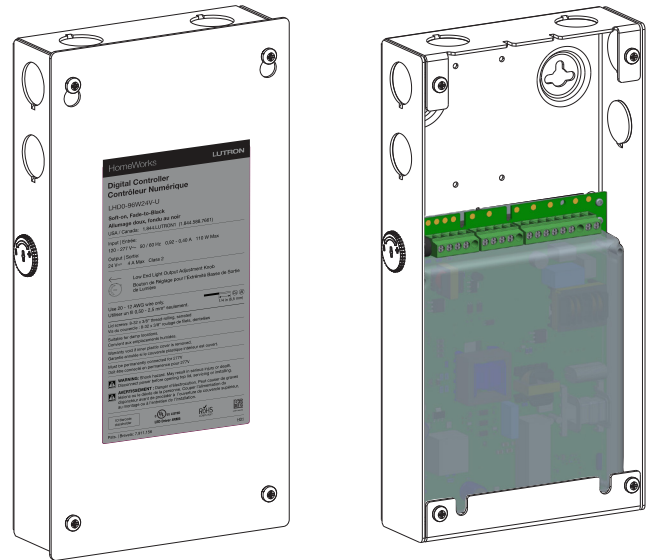

HomeWorks Digital 0.1% Constant Voltage Controller
5.5 in (140 mm) W x 2.0 in (51 mm) H x 10.5 in (267 mm) L

¹ Light output at 0.1% depends on installation and light engine efficacy.

² Soft-on, Fade-to-Black dimming technology is not available for 3-wire controls.

SPECIFICATION SUBMITTAL

Page

Job Name:

Model Numbers:

Job Number:

Specifications

Regulatory Approvals and Compliance

- Lutron Quality Systems registered to ISO 9001.2015
- Manufacturing facilities employ ESD reduction practices that comply with the requirements of ANSI/ESD S20.20
- Meets ANSI C62.41 category A surge protection standards up to and including 4 kV
- FCC Part 15
 - Class A (277 V \sim)
 - Class B (120 V \sim)
- CAN ICES-005 (A) (277 V \sim)
- CAN ICES-005 (B) (120 V \sim)
- LED controllers need to meet certain performance criteria in order for the completed luminaires to comply with Title 24 2019 requirements as detailed in Joint Appendix 8. All models meet both commercial (at 120 V \sim /277 V \sim) and residential (at 120 V \sim) performance criteria throughout their entire load operating regions. Consult 2019 Residential Compliance Manual, Example 6-3 Fade-in Lighting for important information on meeting start-up time requirements with fade-in lighting.
- Meets UL[®] 8750/CSA C22.2 No. 250.13-14, “Light Emitting Diode (LED) Equipment For Use in Lighting Products”
- Class 2 output; meets UL[®] 1310/CSA C22.2 No. 223-M91

Performance

- Dimming Range: 100% to 0.1%¹
- LED lighting turns on to any dimmed level without flashing to full brightness
- Operating Voltage: 120/277 V \sim at 50/60 Hz
- Rated lifetime of 50,000 hours at 40 °C (104 °F) ambient temperature and maximum loading
- For rated warranty, ambient temperature (t_a) not to exceed 40 °C (104 °F) (maximum rated temperature)^{2,3}
- Patented thermal fold back protection
- Non-volatile memory restores all controller settings after power failure
- Typical standby power consumption: 0.25 W at 120 V \sim and 0.4 W at 277 V \sim
- Open-circuit protected output
- Short-circuit and overload-protected output
- Output: 24 V \equiv constant voltage at high-end
- Output Load Range: 2 W to 96 W at high-end
- Power Factor: > 0.90 at maximum power
- Total Harmonic Distortion (THD): < 20% at maximum power
- NEMA 410 – 2011 compliant
- Inrush Current Limiting Circuitry: decreases circuit breaker tripping, switch arcing and relay failure; allows full loading of switch leg
- Inrush Current: < 2 A
- Device turn-on time: < 100 ms from electronic off and, < 500 ms from power off
- LHD0-96W24V-U controller is programmed by Lutron manufacturing and is NOT configurable by the Lutron QwikFig configuration system

¹ Light output at 0.1% depends on installation and light engine efficacy.

² To maintain warranty, installer is responsible for ensuring that the controller ambient temperature does not exceed 40 °C (104 °F).

³ Where t_a is the temperature of the air directly surrounding the controller.

Job Name:	Model Numbers:
Job Number:	

Specifications (continued)

Environmental

- Sound rated: Class A inaudible in 24 dBA ambient
- Relative Humidity: maximum 90% non-condensing
- Minimum Operating Ambient Temperature: $t_a = 0\text{ }^\circ\text{C}$ (32 $^\circ\text{F}$)¹
- Indoor use only
- Rated for dry and damp locations
- Meets NEC® requirements for installation in “other space used for environmental air”²
- Meets the Canadian National Building Code Plenum Requirements for a concealed space used as a plenum within a floor or roof assembly
- Maximum heat output of module: 46 BTU/hour

Controller Wiring and Mounting

For best installation practices, please refer to Application Note #591 at www.lutron.com.

- Mount the controller in a position where it can be easily located and accessed if service or troubleshooting is necessary.
- Controller is grounded by terminal connection
- Must be permanently connected, fixed wiring for 277 V~ application
- Terminal blocks on the controller accept solid or stranded wire per terminal from 20 AWG to 12 AWG (0.50 mm² to 2.5 mm²).
- Maximum wire length between the LED controller and the start of the linear strip for different wire sizes is listed below. The table below can be used independently of the line voltage that is powering the LED controller.

Wire Gauge	Maximum Lead Length
24 AWG (0.20 mm ²) ³	6 ft (1.8 m)
22 AWG (0.34 mm ²) ³	10 ft (3.0 m)
20 AWG (0.50 mm ²)	15 ft (4.5 m)
18 AWG (0.75 mm ²)	25 ft (7.62 m)
16 AWG (1.0 mm ²)	40 ft (12.2 m)
14 AWG (1.5 mm ²)	60 ft (18.3 m)
12 AWG (2.5 mm ²)	100 ft (30.5 m)
10 AWG (4.0 mm ²) ³	150 ft (45.7 m)

¹ Where t_a is the temperature of the air directly surrounding the controller.

² Additional considerations may be required based on state and local codes and standards.

³ To use wire gauge larger or smaller than terminal blocks' rated gauge of 20 AWG to 12 AWG (0.50 mm² to 2.5 mm²), connect 1 ft (0.3 m) or less of rated wire from terminal and connect with larger or smaller wire.

Terminal Block Details

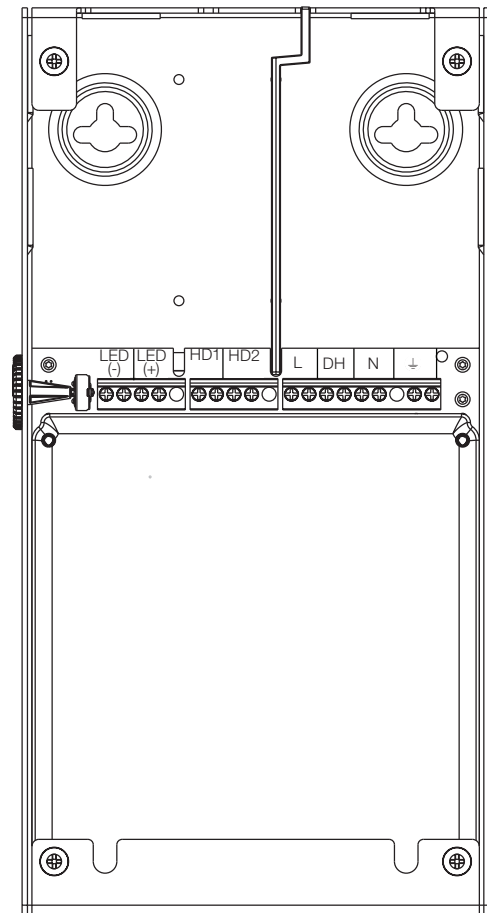

Job Name:

Model Numbers:

Job Number:

Models Available

		Model	Input Voltage (V~)	Input Current ¹ (A)	Typical Power Factor ¹	Typical THD ¹ (%)	Output Power (W)	Output Voltage ¹ (V==)
3-Wire or HomeWorks Digital Control ²	For 24 V== Constant Voltage LED Loads	LHD0-96W24V-U	120	0.92	0.99	8	2-96	24
			277	0.40	0.94	13	2-96	24

¹ At maximum output power.

² For wiring options, see *Wiring* section, pages 8-10.

Efficiency vs. Output Power

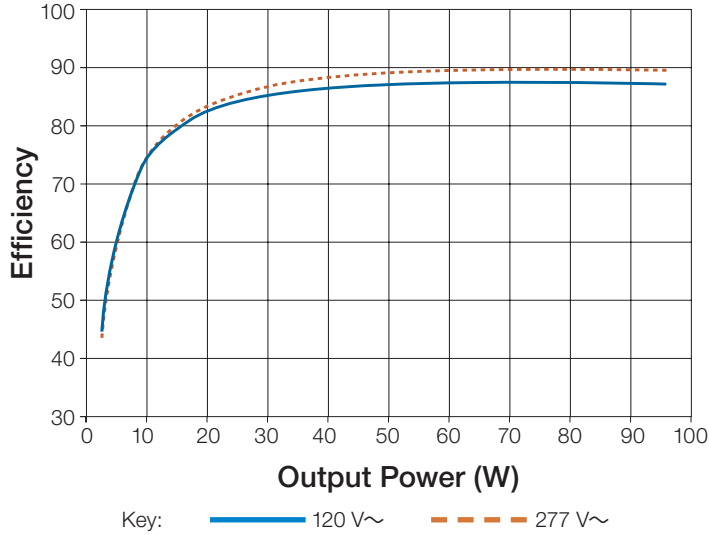

THD vs. Output Power

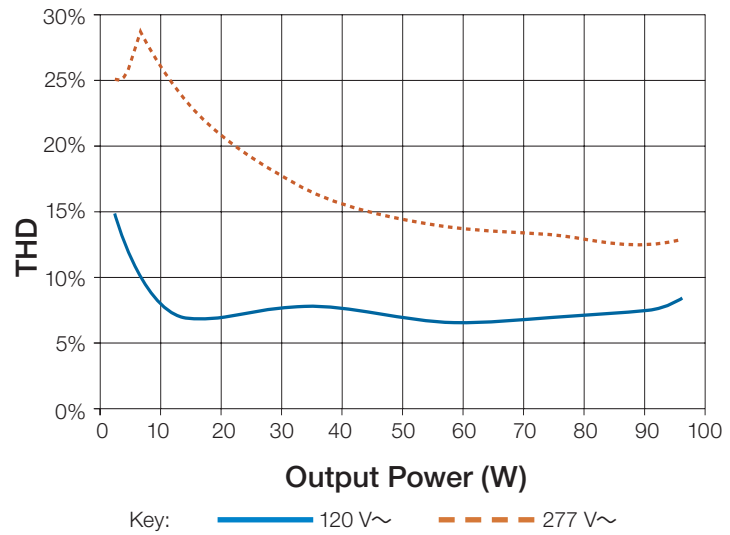

Power Factor vs. Output Power

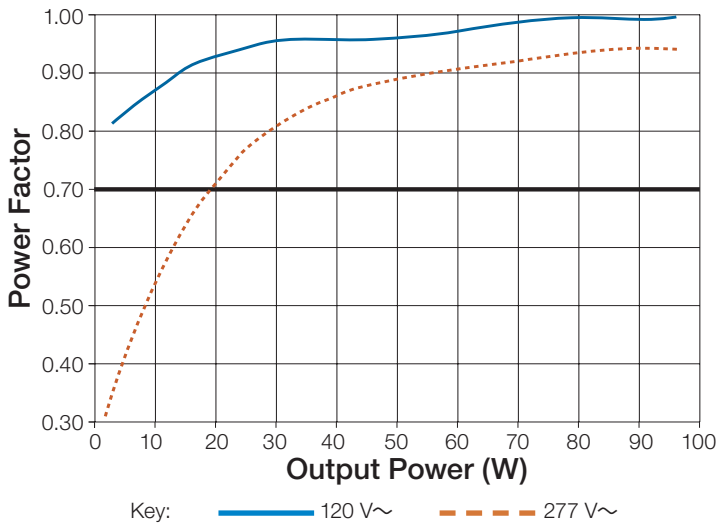

Output Voltage vs. Output Power

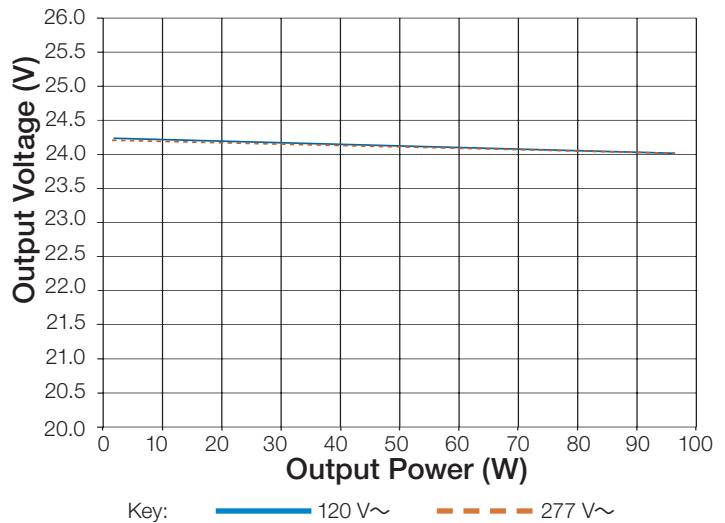

NOTE: Specifications are subject to change without notice.

Job Name:	Model Numbers:
Job Number:	

Mounting Options 1,2

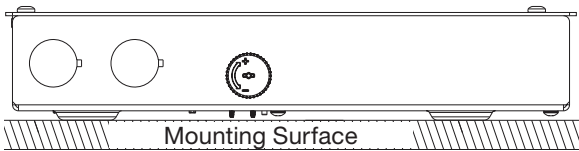
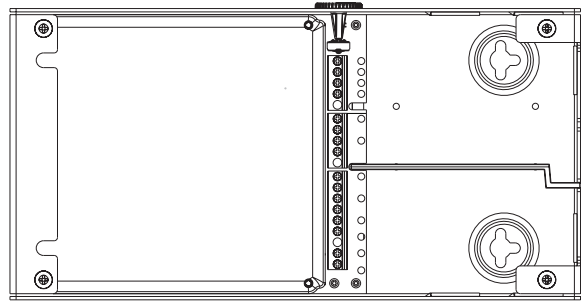
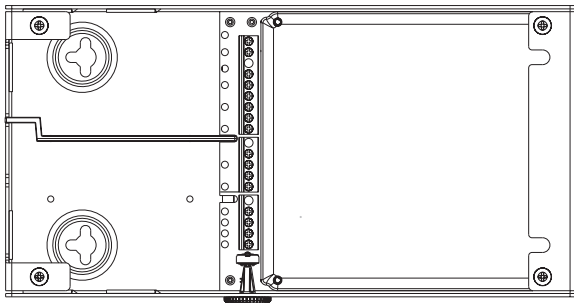
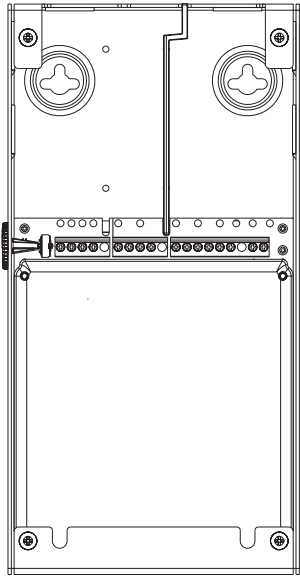

- 1 Any other mounting configuration will require additional mechanical support. Improper installation may result in hazards to personnel or property.
- 2 Mount the controller in a position where it can be easily located and accessed if service or troubleshooting is necessary.

Job Name: Job Number:	Model Numbers:
------------------------------	----------------

Barrier Installation and Controller Spacing Requirements

Measurements are shown as: in (mm)

Option 1

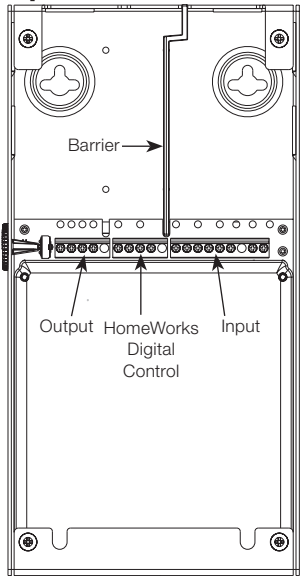

Option 2

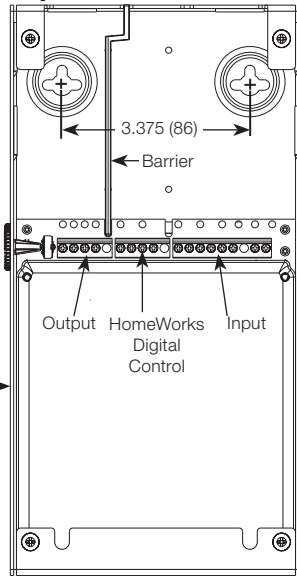

← ≥ 3.0 (76) →

↑ ≥ 3.0 (76) ↓

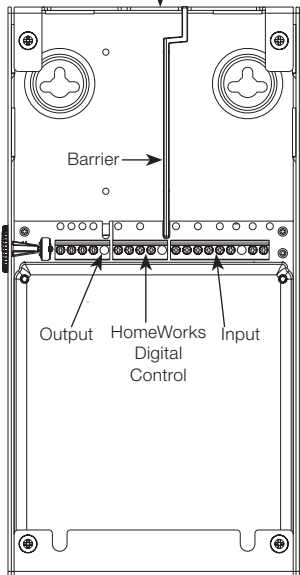

- Optional barrier can be placed either between the input and HomeWorks digital control terminals (**Option 1**) when the HomeWorks digital links are wired as Class 2 or between the HomeWorks digital control and output terminals (**Option 2**) when the HomeWorks digital links are wired as Class 1.
- For 3-wire control, barrier could be placed in either location.
- The HomeWorks digital link may be wired as Class 1 or Class 2. Please refer to Application Note #142 at www.lutron.com
- Maintain a minimum of 3.0 in (76 mm) between any two HomeWorks digital 0.1% controllers.

Job Name:	Model Numbers:
Job Number:	

Wiring

LHD0 Models: 3-Wire Controls (third wire required for control signal) Wiring Diagram

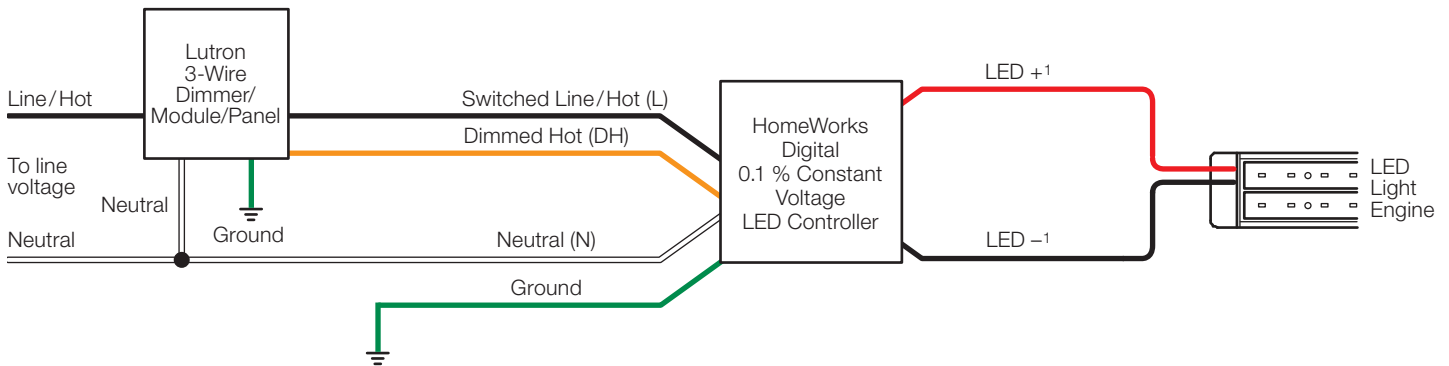

Compatible Controls without Soft-on, Fade-to-Black dimming technology: Lutron 3-Wire Controls⁵

Guaranteed performance specifications with the controls listed in the chart below.

For assistance selecting controls, contact our LED Center of Excellence at **1.877.346.5338** (U.S.A. and Canada only) or **LEDs@lutron.com**

Product	Model Number		Controllers per Control ²		Load Type	Low-end Trim Setting
	120 V~	277 V~	120 V~	277 V~		
Nova T★ dimmer	NTF-10-	NTF-10-277-	1-16	1-19	—	—
	NTF-103P-	NTF-103P-277-	1-8	1-14	—	—
Nova dimmer	NF-10-	NF-10-277-	1-16	1-19	—	—
	NF-103P-	NF-103P-277-	1-8	1-14	—	—
Skylark dimmer	SF-10P-	SF-12P-277-	1-8	1-14	—	—
	SF-103P-	SF-12P-277-3-	1-8	1-14	—	—
Diva dimmer	DVF-103P-	DVF-103P-277-	1-8	1-14	—	—
	DVSCF-103P-	DVSCF-103P-277-	1-8	1-14	—	—
Ariadni dimmer	AYF-103P-	AYF-103P-277-	1-8	1-14	—	—
Maestro dimmer	MAF-6AM-	MAF-6AM-277-	1-6	1-14	—	—
	MSCF-6AM-	MSCF-6AM-277-	1-6	1-14	—	—
Maestro Wireless dimmer	MRF2-F6AN-DV-		1-6	1-14	—	—
RadioRA 2 dimmer	RRD-F6AN-DV-		1-6	1-14	Dual voltage 3-wire dimmer	21% ⁴
HomeWorks QS dimmer	HQRD-F6AN-DV-		1-6	1-14	Fluorescent 3-wire LED 3-wire	21% ⁴
Interfaces ³	PHPM-3F-120-	—	1-16	—	—	—
	PHPM-3F-DV-		1-16	1-38	—	—
GP dimming panels	Various		1-16	1-38	2-1	—

¹ For the maximum wire length between the LED controller and the start of the linear strip, see charts in the **Controller Wiring and Mounting** section.

² No derating required in multi-gang applications provided that the fixture-count does not exceed the quantity listed.

³ Please refer to interface specification sheet for compatible system list.

⁴ Trim level allows the ability to get to 0.1% but might result in dead travel for 1%–4% on user interface for some installations. In this instance, 22% trim level could be used to avoid dead travel but might result in >0.1% dim level.

⁵ Soft-on, Fade-to-Black dimming technology is not available for 3-wire controls.

Note: For information about Legacy product use in existing control applications, contact LEDs@lutron.com

Job Name:	Model Numbers:
Job Number:	

Wiring (continued)

LHD0 Models: HomeWorks Digital Controls

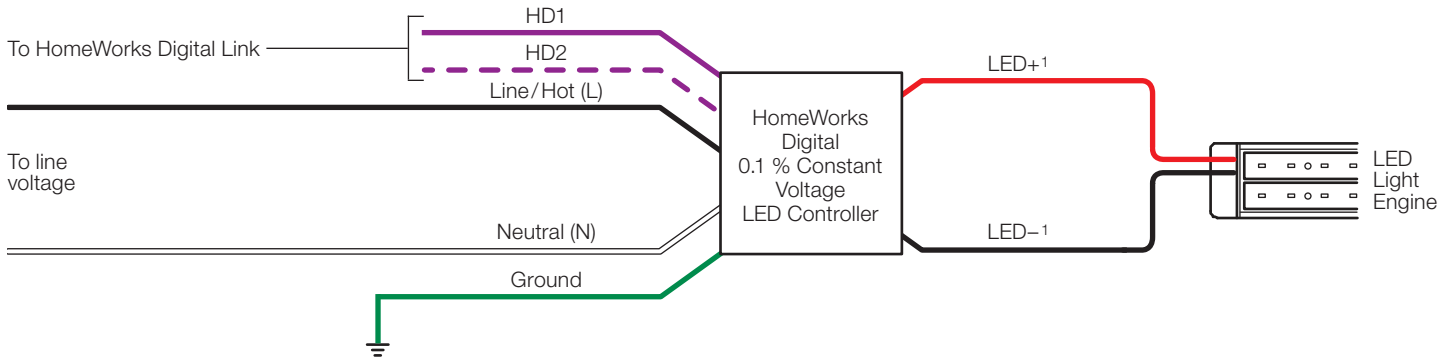

Compatible Controls with Soft-on, Fade-to-Black dimming technology: Lutron HomeWorks Digital Controls

Guaranteed performance specifications with the controls listed in the chart below.

For assistance selecting controls, contact our LED Center of Excellence at **1.844.LUTRON1** (U.S.A. and Canada only) or **LEDs@lutron.com**

Product	Model Number		Recommended System Version	Controllers per Control
	120 V~	277 V~		
HomeWorks QSX	LQSE-2HDC-D	—	10 or higher	64 per HomeWorks digital link

¹ For the maximum wire length between the LED controller and the start of the linear strip, see charts in the **Controller Wiring and Mounting** section.

Job Name:	Model Numbers:
Job Number:	

Wiring (continued)

Continuous LED Light Run

In a continuous LED light run, it is best to connect the load wires in the middle of the LED light run. Please consult load manufacturer best practices for any additional consideration in load installation.

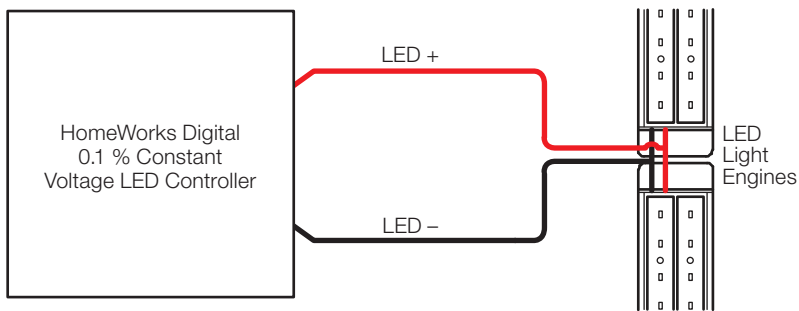

When connecting several LED light homeruns, ensure that the wire lengths and wattages match as closely as possible for best performance.

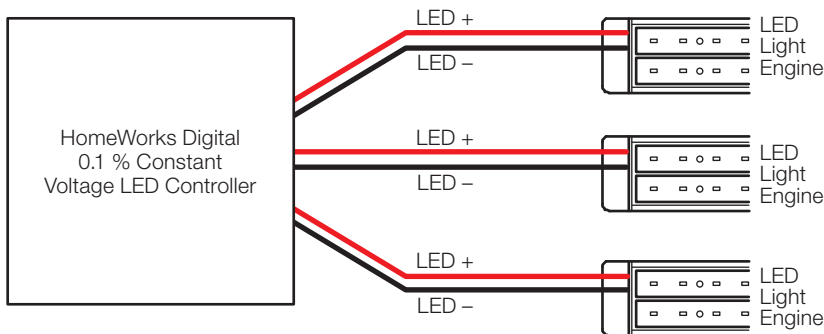

For installation best practices, please refer to Application Note #591 at www.lutron.com

Job Name:	Model Numbers:
Job Number:	

HomeWorks Digital Wiring

HomeWorks Digital Link Overview

- The HomeWorks digital link wiring (HD1 and HD2) connects the digital controllers only together to form a lighting control system.
- Sensors do not connect directly to controllers. Sensors are integrated through the HomeWorks module.
- HD1 and HD2 (HomeWorks digital link wires) are polarity-insensitive and can be wired in any topology.
- Power is supplied to the HomeWorks digital link from the control system.
- Protected from miswires of input power, up to 277 V~, to HomeWorks digital control inputs.

HomeWorks Digital Link Wiring

- HomeWorks digital link terminals accept 20 AWG to 12 AWG (0.50 mm² to 2.5 mm²) solid or stranded copper wire per terminal.
- Make sure that the supply breaker to the controllers and HomeWorks digital link supply is OFF when wiring.
- HD1 and HD2 terminals of the controllers can be daisy chained as shown to the right.
- Using two different colors for HD1 and HD2 will reduce confusion when wiring several controllers together.
- The HomeWorks digital link may be wired Class 1 or Class 2 (See Lutron Application Note #142 at www.lutron.com for more details). Consult applicable electrical codes for proper wiring practices. Ensure that the barrier placement is consistent with this wiring choice.
- For emergency wiring, please refer to Lutron Application Note #106 at www.lutron.com

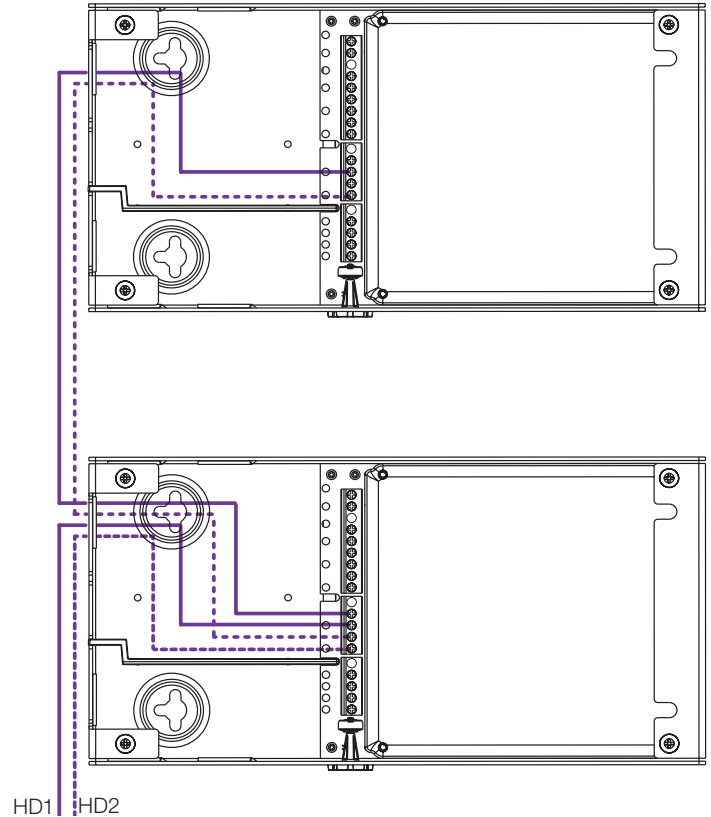

Notes

- The HomeWorks digital link supply does not have to be located at the end of the digital link.
- HomeWorks digital link length is limited by the wire gauge used for HD1 and HD2 as follows:

Wire Gauge	Digital Link Length (max)
12 AWG	2200 ft
14 AWG	1400 ft
16 AWG	900 ft
18 AWG	550 ft
20 AWG	352 ft

Wire Size	Digital Link Length (max)
2.5 mm ²	828 m
1.5 mm ²	517 m
1.0 mm ²	310 m
0.75 mm ²	207 m
0.50 mm ²	155 m

Job Name:	Model Numbers:
Job Number:	

Field Adjustment Knob

The Field Adjustment Knob is located on the side of the HomeWorks digital 0.1% constant voltage controller (LHD0) enclosure. This feature enables the customer to tune the lowest light output achieved during normal operation. An example of this scenario is shown in the image below. Adjusting the Field Adjustment Knob of the lower light output controller minimizes the light output difference and sets the low-end light level at 0.1%. This feature **only needs** to be used in cases of mismatched loads that are separately controlled by 2 or more units.

Figure 1: Cove Lighting with Mismatched Light Output at Low-End Due to Installation Variability

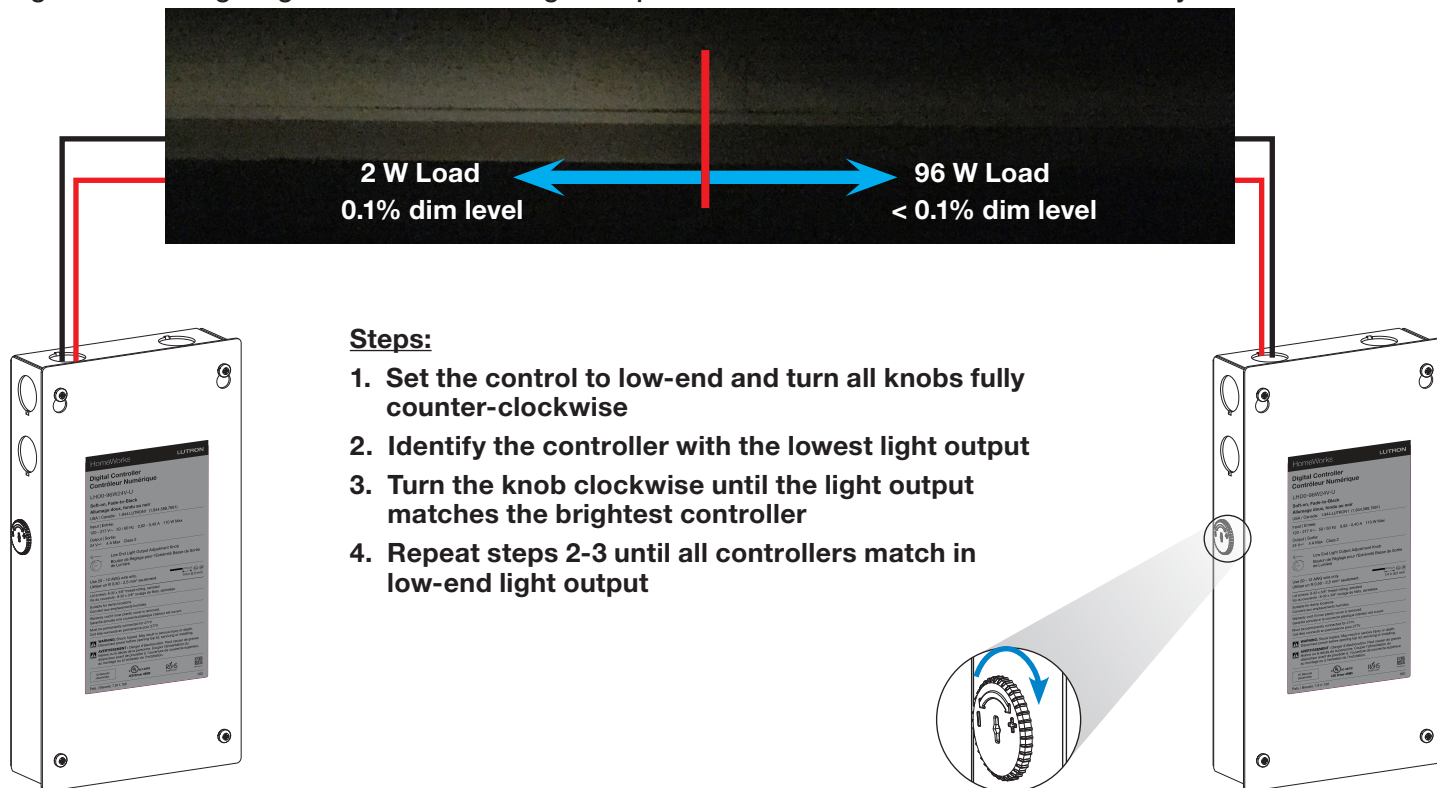
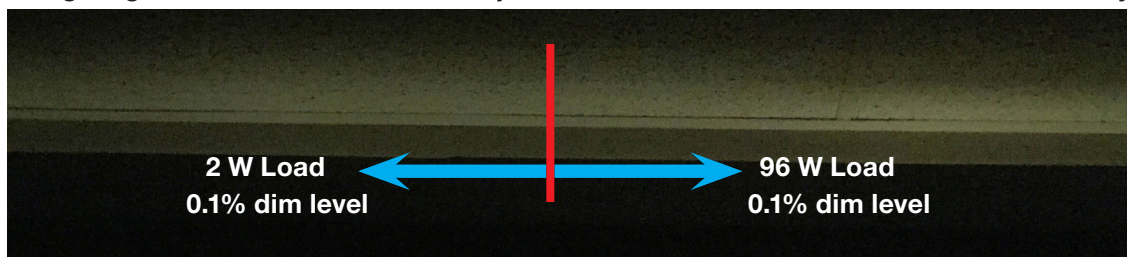

Figure 2: Cove Lighting After the Use of the Field Adjustment Knob Eliminates Mismatch without Costly Re-wiring



The Field Adjustment Knob cannot fix light level mismatch among loads on the same controller. For example, two homeruns of different wattage. For increasing the minimum light output of all the controllers in a space, please use the control's low-end trim feature. Using the Field Adjustment Knob for this purpose will degrade On/Off transition performance.

Job Name:	Model Numbers:
Job Number:	

Facilities Manager

This device complies with part 15 of the FCC Rules. Operation is subject to the following two conditions: (1) This device may not cause harmful interference, and (2) this device must accept any interference received, including interference that may cause undesired operation. Modifications not expressly approved by Lutron Electronics Co., Inc. could void the users authority to operate this equipment.

277 V~ NOTE: This equipment has been tested at 277 V~ and found to comply with the limits for a Class A digital device, pursuant to part 15 of the FCC Rules. These limits are designed to provide reasonable protection against harmful interference when the equipment is operated in a commercial environment. This equipment generates, uses, and can radiate radio frequency energy and, if not installed and used in accordance with the instruction manual, may cause harmful interference to radio communications. Operation of this equipment in a residential area is likely to cause harmful interference in which case the user will be required to correct the interference at their own expense.

120 V~ NOTE: This equipment has been tested at 120 V~ and found to comply with the limits for a Class B digital device, pursuant to part 15 of the FCC Rules. These limits are designed to provide reasonable protection against harmful interference in a residential installation. This equipment generates, uses and can radiate radio frequency energy and, if not installed and used in accordance with the instructions, may cause harmful interference to radio communications. However, there is no guarantee that interference will not occur in a particular installation. If this equipment does cause harmful interference to radio or television reception, which can be determined by turning the equipment off and on, the user is encouraged to try to correct the interference by one or more of the following measures:

- Reorient or relocate the receiving antenna.
- Increase the separation between the equipment and receiver.
- Connect the equipment into an outlet on a circuit different from that to which the receiver is connected.
- Consult the dealer or an experienced radio/TV technician for help.

Service

Controller Warranty

For warranty information, please visit www.lutron.com/driverwarranty

Replacement Parts

When ordering Lutron replacement parts, please provide the full model number. Consult Lutron if you have any questions.

Further Information

For further information, please visit us at www.lutron.com or contact our LED Control Center of Excellence at **1.844.LUTRON1** (U.S.A. and Canada only) or **LEDs@lutron.com**

The Lutron logo, Lutron, HomeWorks, Pico, Nova T⁺, Nova, Skylark, Diva, Ariadni, Maestro, Maestro Wireless, RadioRA, Soft-on, Fade-to-Black, and QwigFig are trademarks or registered trademarks of Lutron Electronics Co., Inc. in the US and/or other countries.

All other product names, logos, and brands are property of their respective owners.

Job Name:	Model Numbers:
Job Number:	